

B&W LCD With Full Keypad

Installation Guide

Contents

1. Before Installing	1
1.1 Notice	1
1.2 Encasement list	3
1.3 Other required equipment	5
2. The illustration of system construction	6
3. Installation and Using	7
3.1. Installation fingerprint machine	7
3.2 C2 controller installation	8
3.3 Fingerprint machine connection with controller.	9
3.4 Installation Video Phone	9
3.5 Video Phone wiring between fingerprint machine and C2 controller box	10
4 View of C2 panel	12
4.1 each side port of C2	12
4.2 Description for each terminal and port	13
4.2.1 Input and output port to control lock	13
4.2.2 RS232/ RS485 export port (unable to send two type of signal at some time)	18
4.2.3 RJ45 out socket (To connect with a compute or switcher)	19
4.2.4 Alarm relay out port (JX1)	20
4.2.5 Door Bell (J11)	21
4.2.6 Reset button (Reset)	22
4.2.7 Clear button (Default).....	22
4.2.8 C2 connection with fingerprint machine	23
5. Video Phone introduction	25
6. User Guide	27
6.1 Fingerprint machine.....	27
6.2 The usage of video phone	28
7. Product Special	29

8. Troubleshooting 32

1. Before Installing

1.1 Notice

Our product is a mass-produced product. It strictly follows to the criteria of manufacture and inspection of China, U.S.A, and EU. This file contains important information. It is better for you to read it carefully prior to use. If you ignore it, the incorrect installation may cause the unit damage. Although we could do our best to offer you service, the neglect to the file could cause unwanted cost for you.

1. Before installation, please make sure the power is cut off, because it is very dangerous if the power is on. The short-circuit of power cable may cause the core parts damage.

2. All exposed part of connection wire end can not be exceeded 5mm to prevent the bared wire accidental connection which leads to machine break down. And also suggest using different colour cable to connect.

3. In the place where the static is strong or in winter, please connect the grounding firstly, in order to prevent the instant mass static damage the machine.

4. Connect power supply with device in the last for the wiring connection. If you find any unusual thing occur, please firstly cut off the power, then go to examine. Keep in mind: wiring operation under power on will lead to machine sudden damage; we are not liable for damages and trouble due to such operation.

5. The height to mount device is about 1.4-1.5 meter

After installation, please take off protection film on the fingerprint sensor to get best recognize result.

6. After installation finish, when go to test the exit-door button, please keep a personal in the outside, because sometimes the accidental issue can bring on you are not able to go outside.

7. Our equipment offer an automatically function, please after the installing finish. Run the auto-test function to confirm the installation

finish .

In order to guarantee machine run for long time, we set an auto-sleep and wake up function in the exit factory, please carefully examine this function normally setting before using.

8. We recommend using above the 12V/3A direct-current supply for ZK software's access control device, electricity lock better to powered by 12VDC, and no more than 1.5 A electric current. At this time, the electric current of supply should be above 1A than lock power. If the parameter of lock power surpasses this scope, please connect technical personnel. If the power had not met above requests, it possibly causes to be unable normally to drive the electricity lock, even damage the device.

9. Before device to be connected please read and always follow "Quick connect Guide" closely. Because the wrong wiring will cause the core block and sensor to burn out, insult in device to break down, at this cause ZK Software is not liable for any damages and trouble.

10. If the space between power adapters and device is too long, please do not use the twisted-pair or other type ferrules for the power wire. When the power wire is choused, you should consider attenuation of voltage which has passed long distance transfer.





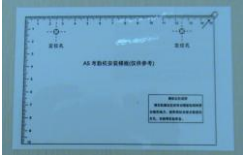
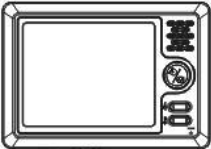
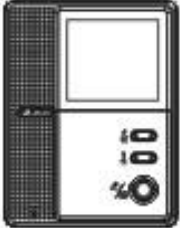

11. Please use specialized RS485 cable and the RS232/485 converter with power to hookup the network, the bus structure apply to connect with each device. When a long cable is used to transfer signal, it is need to connect a matching resistance to receiver, and its value is 120Ω .

12. Other not details items; please see also the user handbook, the operating instructions and the appendix and so on

1.2 Encasement list









product	picture	Amount	Purpose
Fingerpri nt Machine.		1Unit	
Mounting Paper.			To determine the position for fixing fingerprint machine, prepare to drill hole and wiring.
Video Phone	 <p data-bbox="322 975 482 1002">Colour Screen</p>  <p data-bbox="284 1249 507 1276">Black-white Screen</p>		One Machine with one Video Phone

B&W LCD with full keypad Installation Guide

Comm. controller		1Unit	Supply power to fingerprint machine
Power cable			
Data cable			Used to fingerprint machine and Controller
Fix bolt			Fix the mounting plate on the wall
RS232 linking cable			Used to RS232 Communication
		1set	
manual			

1.3 Other required equipment

The following equipment is not included in the standard package.

Name	Picture	Name	Picture
PC		Door Lock	
Door sensor		Release door button	
Alarm		RS485/ RS232 converter	
Door Controller		Network Cable	

2. The illustration of system construction

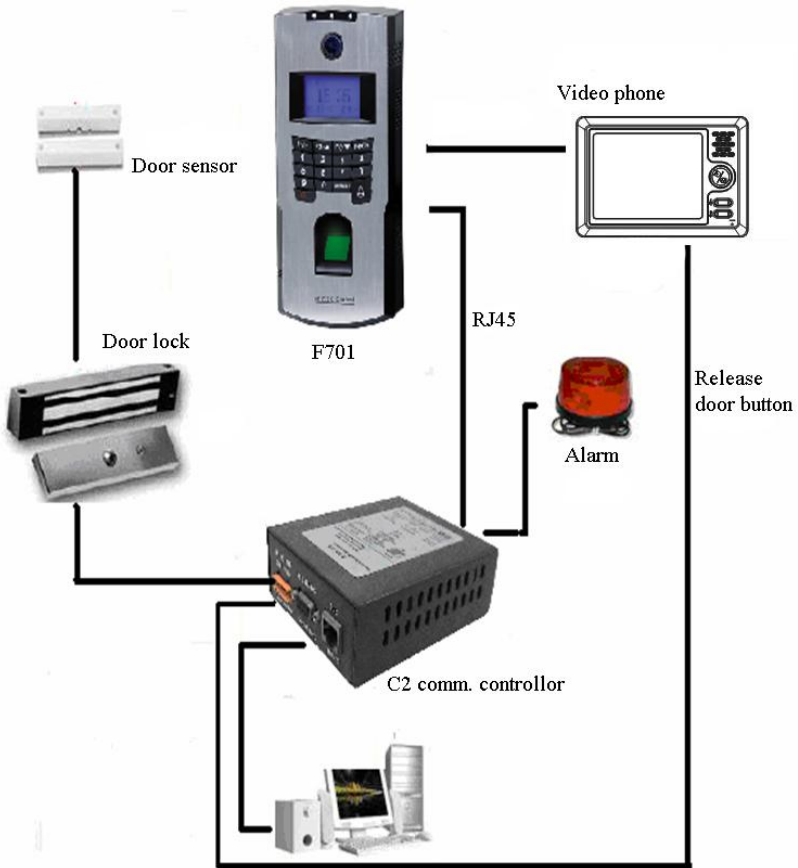

3. Installation and Using

3.1. Installation fingerprint machine

- 1**、determine the position of fingerprint machine on the wall. The fingerprint machine should be mounted on the external wall of the door approximately 1400mm from the ground to the unit bottom.
- 2**、take out a mounting template which along with this fingerprint machine, stick it on the determined position, follow illustration of the template to drill hole
- 3**、Make the hole of mounting plate meet the drilled hole on the wall, Use the screw to fix it on the wall. After installation, please make sure the mounting plate is reliable, fasten, not loosed.
- 4**、Connect C2 and Video Phone with F701 fingerprint machine, like as Figure 1 show
- 5**、Confirm all connection plugs correctly. Align back iron-plate of fingerprint machine body to mounting plate properly, and push it up, then push device backward, Turn and tie up the screw bottom. After finishing installation, make ensure the body of device is fixed tightly.

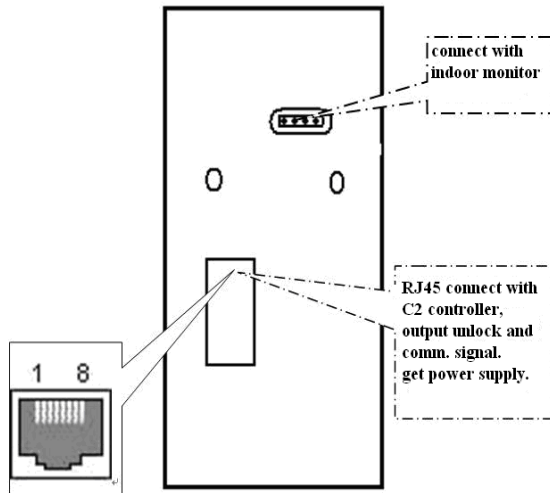

Figure1.fingerprint machine connection port

3.2 C2 controller installation

Determine the position of nail on the wall, the controller should be mount on the inter wall of the door, after the position is determined, you can hammer two nail in the wall. Put the box on the wall.

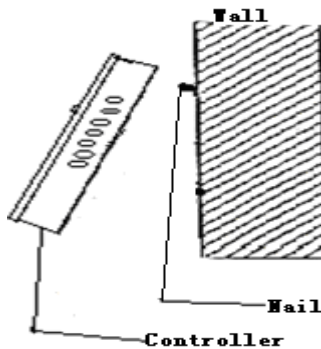

Figure2 controller installation Illustration

3.3 Fingerprint machine connection with controller.

Through the data cable may create a connection between the fingerprint machine and C2 communication controller, like as following illustration.

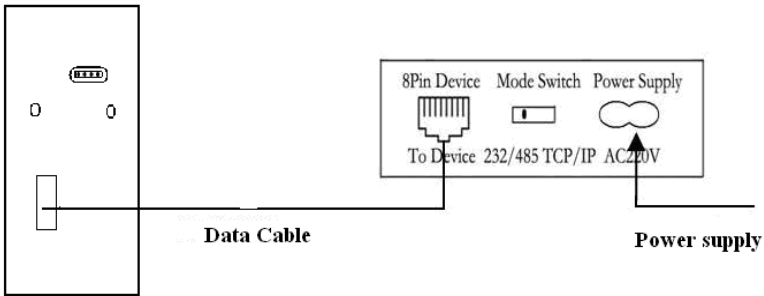
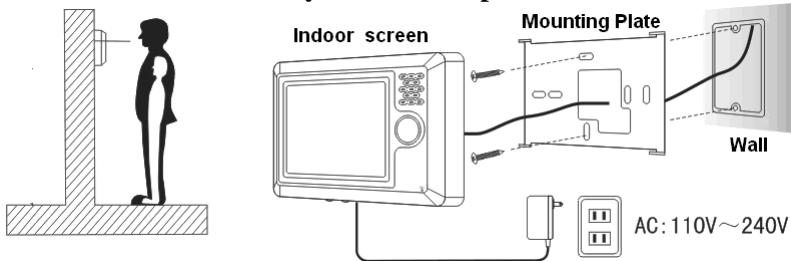

Figure 3 fingerprint machine and controller connection illustration.

3.4 Installation Video Phone

Utilize the terminal to connect fingerprint machine and the camera viewing area, like as following illustration

Illustrate the installation by colour video phone



Determine the highness of installation video phone according to view.

Firstly fix the mounting plate with the two supplied screws. Then mount the video phone

Detail step

1、 implant the four seals into the foot of the monitor, shown as follow :

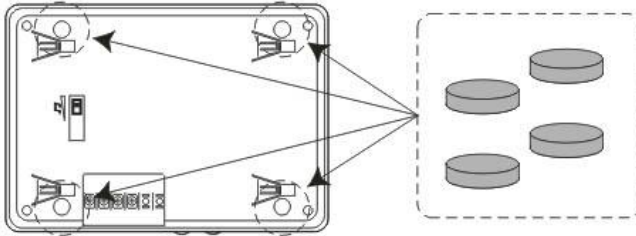

2、 Push the video phone from the left to right, ensure the hook latch in.

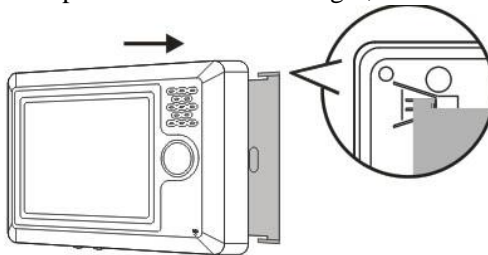

3.Pull the monitor down forward, make sure the video phone is reliable, fasten , no loosed.

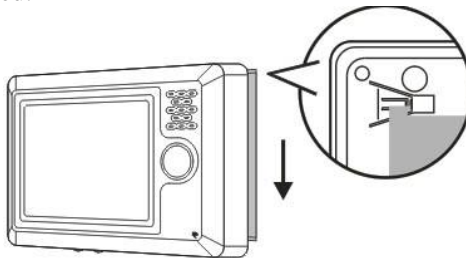

3.5 Video Phone wiring between fingerprint machine and C2 controller box

The video phone shown as following

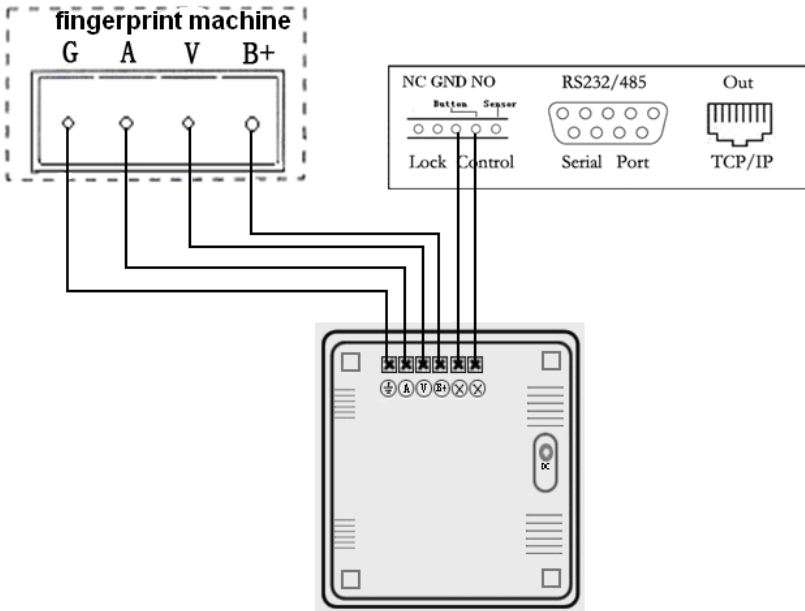

Video Phone wiring illustration

4 View of C2 panel

4.1 each side port of C2

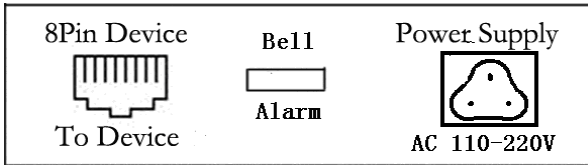

Left : RJ45 jack. Use only the manufacturer provided Data Cable approved for use with this equipment. This accepts a plug of Data Cable at one end and attaches to fingerprint machine at the other.

Center : This is a Socket that extends the peripheral alarm and door bell.

Right: Power supply socket, AC220 V in

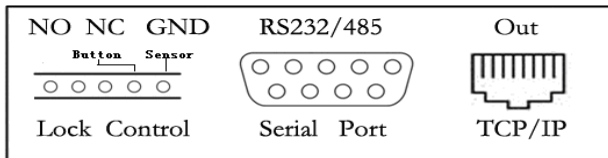

Left: The terminal for lock, door sensor, release button.

Center: RS232/485 serial port, here is RS 232/RS485 cable outlet and attach é to PC serial port.

Right: Network RJ45connector, that accepts a plug at one end and connect switcher or directly connect PC .

Like as above picture illustrate, there are two buttons on the cooler hole of C2 communication, that are reset button and Restore Default button.

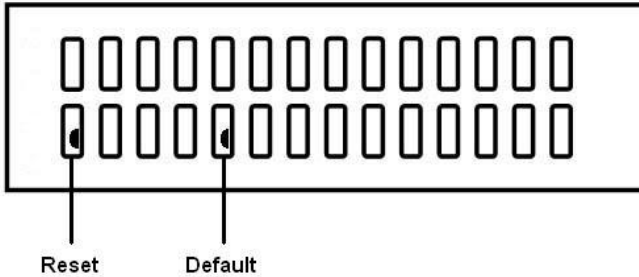

4.2 Description for each terminal and port

Caution: Do not attempt to open C2 box cover yourself unless you are a trained service technician.

4.2.1 Input and output port to control lock



The terminal from the left to right are NC , GND, NO, Button, Sensor

The lock connect with NC, GND, NO terminal

Normally close (NC), under normal state the equipment keep up closed, if force the equipment open, the circuit cut off, bring out the state change.

Normally Open (NO), under normally state the circuit is cut off, if force the equipment open, the circuit will be closed, produce a state

change.

Power Ground (GND), Current loop ground

Input terminal of door sensor (Sensor, GND) the input port of door sensor accepts the signal which come from normally closed contact to detect the door opening and closing state, when the door is in closed, the contact keep in closed state, if the door is opened by someone, the circuit break, thus bring out state change. If this door is opened by unauthorized user or opening time is too long, the controller will send alarm

Input terminal of release door button (Button, GND) The input port of release door button accepts the signal which come from normally opened contact to indicate that somebody want to go out, the input equipment such as “action detector”, “press sensitivity floor board” or exit-door button all serve as source to send signal, if nobody send out request to want to go out, the input keep disconnection, if somebody want to go out, they trigger release door button, the circuit is closed. Produce state change, the controller responded to the request, unlock and permit door serve as pass way.

Note: the process of performance to unlock door is control by relay, when you install door lock, there are two thing you must think about, -- safety and security, in other words, do you want which result that is if lose control of this door, the door is still in safety—“lost control but safety” or if lose control of this door, the door still is security--- “lost control but security”

“lost control but safety” is that the power supply cut off (maybe the power supply is cut or the controller lose control of itself, the door will be open automatically, and permit everybody freely to pass in and out, the door is not ability to be closed until the system power on, these type of doors are installed in the protective area which ensure everybody is able to pass in and out. One representative application of “lost control but safety” is to use electromagnetism lock, under normal power supply, the door is controlled by the controller, once the power supply break off, the electromagnetism lock will lose magnetism and does not take effect, the door become a pass way

“Lost control but security” is that the power supply cut off, the door will be locked automatically, do not permit external personal to come in, but permit internal personal go out, the door is not to be unlocked until the system power supply is in gear. Make sure that the door of “lost control but security” will be installed in the area which needs to be protected through fair and foul. One representative application of “lost control but security” is to use electrical lock, if the power supply break off, the external personal is not able to open the door, but the internal person can open the by manual operation.

Following figure illustrate normally closed and normally opened join sketch maps

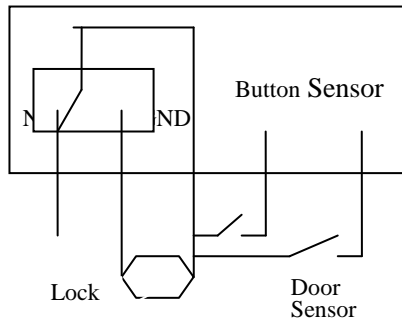

Unlock by power on

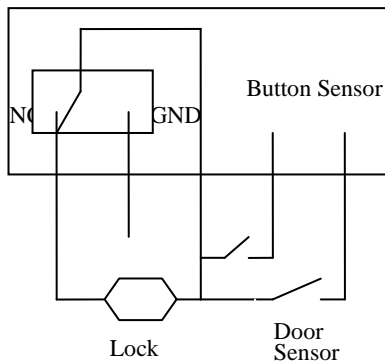

Unlock by power off

In the following three cases, we recommend that fingerprint machine and lock are powered separately.

- ◆ The working voltage of the lock is DC12V, but the current is difference.
- ◆ The lock voltage is not DC12V.
- ◆ The distance between lock and fingerprint machine is too far

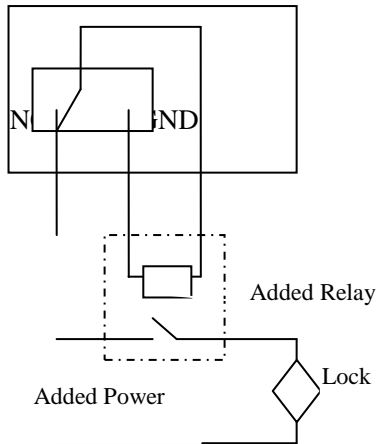

Separate power. Unlock by power on

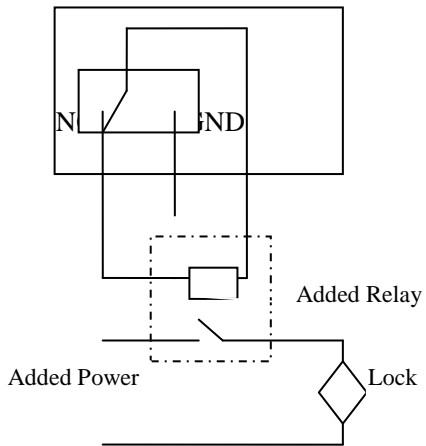

Separate power. Unlock by power off

4.2.2 RS232/ RS485 export port (unable to send two type of signal at some time)

Each pin saves as following description

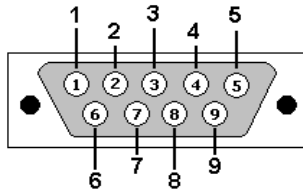

RS232

2---- RTX; 3---TX ; 5— (GND) ; Rest pin is spare

RS485

4— 485A+; 5— GND ; 7— 485B— ; Rest pin is spare

4.2.3 RJ45 in socket (To connect with a front –end fingerprint machine)

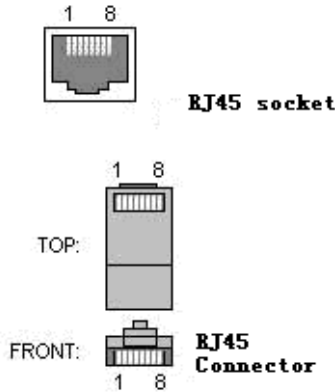

Standard RJ45 PIN number							
1	2	3	4	5	6	7	8
RJ45-1	RJ45-2	RJ45-3	RXD1	GND	RJ45-6	TXD1	+12V
RS485 A	RS485 B	RXD2	WD0	GND	TXD2	WD1	+12V

Note: 1) RXD1, TXD1 realize the RS232 communication between the fingerprint and C2 controller.

2) RXD2, TXD2 realize the RS232 communication between the fingerprint and PC

4.2.3 RJ45 out socket (To connect with a compute or switcher)

Standard RJ45 PIN number							
1	2	3	4	5	6	7	8
TX+	TX-	RX+			RX-		

If you want to connect a doorbell and warner, must open the cover of C2, and find following illustration position JX1 and J11

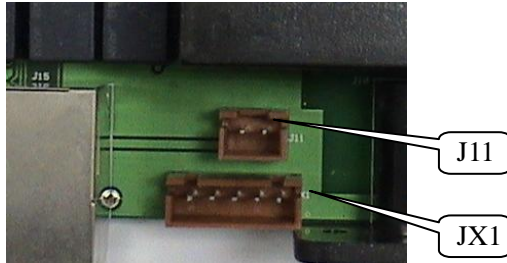

4.2.4 Alarm relay out port (JX1)

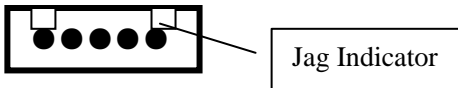

The pins from left to right are NC (normally closed), COM (common power supply), NO (normally open), +12VDC (power supply). Which outlet wire is provided along with the C2 communication controller. To perform the process of sending alarm is controlled by the relay of controller, once power on, the state of relay will change to trigger alarm. To join peripheral power supply way, please reference the joined lock by Separate power

Notice : If you want install the alarm in the out-door, you must use peripheral power supply, if you ignore it, in no event shall manufacturer be liable for any lose arising out of user C2 power supply in the out-door.

Following figure illustrate that the alarm is in normally closed and normally opened

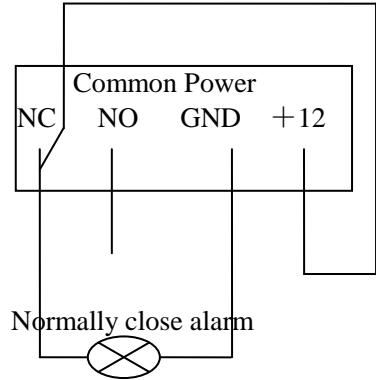
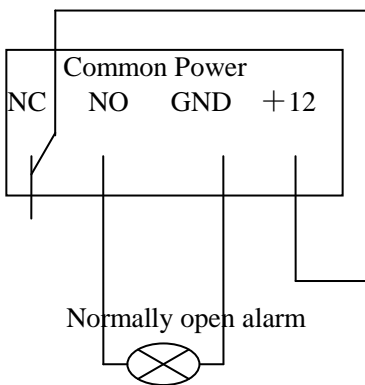

4.2.5 Door Bell (J11)

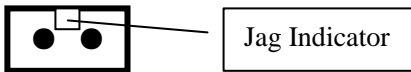

The pin from left to right are positive and negative of the power supply, the bell ring is controlled by replay output.

Notice: The doorbell governed by the special power supply request, Use only original manufactory provided wireless doorbell, doorbell approved for use with this C2. The doorbell power request is 12V, < 200mA.

4.2.6 Reset button (Reset)

If the system failure occur, the fingerprint machine break down, if you may push this button to restart C2 communication controller and front fingerprint to restart default setup

4.2.7 Clear button (Default)

Push this clear button; you may clear the binding ID for between C2 communication controller and front-end fingerprint machine.

4.2.8 C2 connection with fingerprint machine

Each C2 controller and fingerprint machine has a ID to identify each another, you can set C2 correlation parameter through the fingerprint machine, and C2 also can monitor the fingerprint machine work, if the abnormal state occur, the C2 communication controller will respond to the trouble, each control unit not only may independently run, but also create network by may net

Note:: each fingerprint machine may bind more than one C2 communication controller which has not binding ID, but the C2 communication controller don't accept any fingerprint machine except one fingerprint machine until you press clear button

How to the Front –end fingerprint machine input signal into C2 controller

- ◆ RS232, Baud rate 9600
- ◆ The most length to the distance between front-end machine and controller 10 meter。
- ◆ The commend length to the distance between front-end machine and controller no than 3 meter

The binding ID between the fingerprint machine and C2

- ◆ Binding function, the front fingerprint machine and C2 communication can realize the Binding function, after binding , the other fingerprint is unable to communicate with this C2 until the Binding ID is eliminated by hand to push button。
- ◆ You use it at first time, the front–end fingerprint machine send one and only the binding ID to C2 controller.
- ◆ If it fails to connect, the following prompt message will appear

C2 fail to match

C2 fail to Comm.

It separately indicate to fail to match between C2 communication controller and fingerprint machine,. The communication C2 communication controller and fingerprint machine between is failure.

If somebody with hostility object wants to detect the binding ID, C2 will be invalid, and its built-in buzzer will send a urgent tweet “do”, at same time send signal to trigger warner

Each other Monitor work

◆ Monitor front-end fingerprint machine, if the front –end fingerprint machine does not communicate with C2 communication controller within 30 sec. thus the fingerprint machine is thought as it in abnormality state, at this time the C2 communication controller will restart the front–end fingerprint machine.

◆ The front-end fingerprint machine query C2 communication controller state per 10 second, at same time send signal to C2 communication controller for telling its state.

◆ C2 send the information of the door sensor and release button to the fingerprint machine.

If the C2 monitor the front fingerprint machine, and find the communication overtime, C2 built-in buzzer will send a tweet “do” per 5 second. at same time send signal to trigger Warner.

Set C2 option in the front-end fingerprint machine:

Push the menu key of the fingerprint machine -> Option-> Acc opts.

◆ How long time dose the lock to be controlled -- Lock

◆ How long time does check the door sensor to be delayed
-> Desen.Delay

◆ Relive alarm

◆ C2 watch dog , the default time 30 sec.(unchanged)

How long time the alarm cry, the default 10 sec. (unchanged))

5. Video Phone introduction

1. Colour Screen

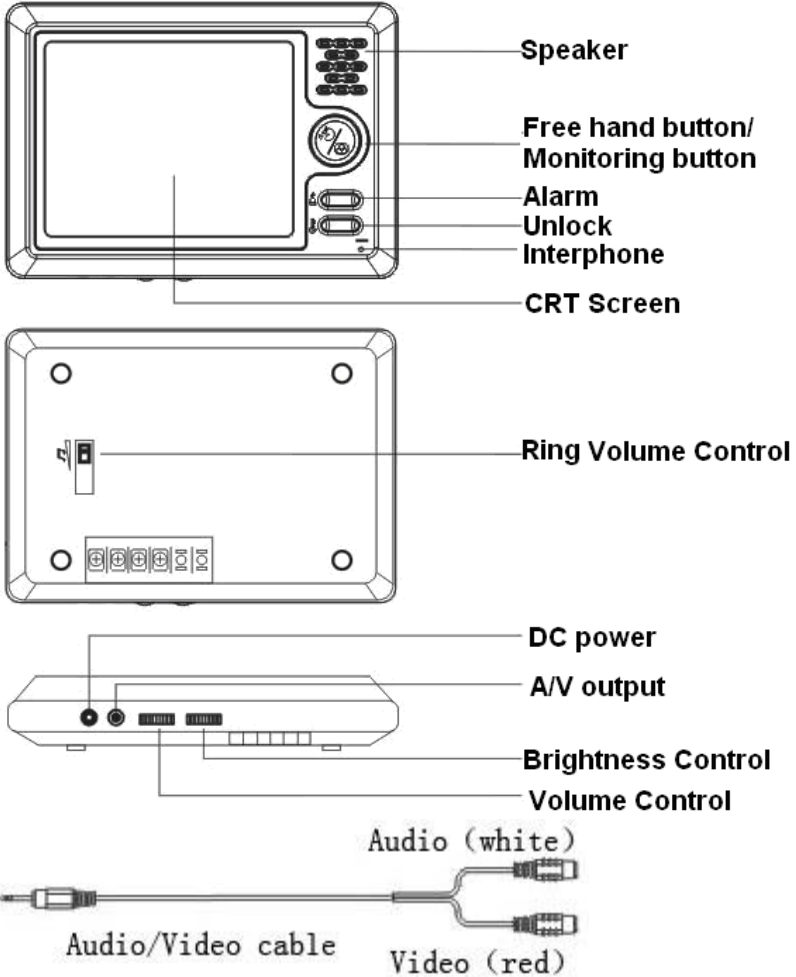

2、Black write screen

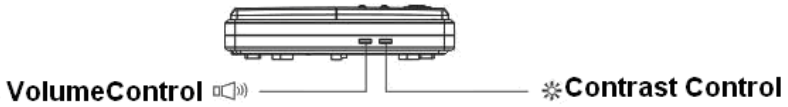
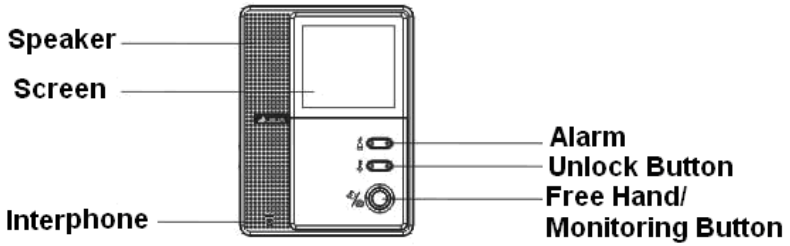

6. User Guide

6.1 Fingerprint machine

After installing the device, pursuant illustration to join the controller and peripheral equipment, be sure the wiring is correct, if it is not need to install the door sensor, please set the Door sensor option as “NO” in the front-end fingerprint machine, avoid the software always alarming. After system power is on. Examine and check the fingerprint machine whether work properly or not, use the Access Control Software to test each controlling unit, if the Access Control software shows that this system is clear and local work already finish.

Before using this Access Control System, user must download user information to corresponding controlling unit, refer to Access Control Software User Guide, and setup each controlling Unit option-- Time Zone, User Group. Group Time Zone, after assigning privilege to each the Door and in-out each door, Initialize the Access Control System in the software, after initialization is successful, so this Access Control system basic preparative work finish (more detail See Access Control Software).

6.2 The usage of video phone

visitors Call:

Visitors can directly press the call button () of the fingerprints machine to inform the person in the room through beautiful sound "Ding Dong" by video phone, the visitors figure will be automatically shown in the monitor screen. If no personal in the room or failure to press the "hands-free" button in a certain period of time, the monitor screen will shut down automatically about 10 minutes later.

After you see the visitor's image, if you want to talk, simply press the "hands-free" button to converse with visitors, after talking, touch the "hands-free" button once again, the monitor will shut down if call more than one minute, the monitor screen will shut down automatically.

Such as allowing visitors entered the house, press the "unlock" button to open the door locks.

Monitor:

When you want to observe the outdoor situation, when standby on you just need to press "Montion" button; the outdoor scenes will be automatically displayed on the screen.

Manual deterrent warning:

When you encounter a malicious or arbitrary rang the doorbell by somebody, can press "alarm" key, fingerprint machine will produce sharp and loud sound of sirens as a warning.

Other operations

If you feel that the ring is inappropriate or the image monitor display is too bright or too dim, you can adjust the respective of "volume" and "brightness" knob in the side of video phone to you are satisfied with the volume and image effects.

7. Product Special

Network Communication

- ◆ One standard RS232/485 or TCP/IP communication input port.
- ◆ One standard TCP/IP communication output port.
- ◆ One standard female DB9 connector, which send RS232 or RS485 signal.
- ◆ Via the front-end fingerprint machine realize the function to switch the communication.

Access Control

- ◆ One Door and one way.
- ◆ Opened door hour (1-5 second ability to adjust).
- ◆ Unlocked hour (1-5 second, ability to adjust).
- ◆ Electrical lock : Ability to connect several of normal opening lock, normal opening electrical drop bolt and electrical lock and electromagnetism lock.

Input and output terminal

- ◆ One relay output to control lock, normal open (NO), normal close (NC).
- ◆ One relay output to control alarm Normal open (NO), Normal close (NC).
- ◆ One terminal for door bell output.
- ◆ One standard terminal for door sensor input.
- ◆ One standard terminal for release button input.

Function button

- ◆ One Reset button.
- ◆ One restore default button.

Multi-alarm

- ◆ Opened door overtime.

- ◆ Anti- dismantles the front-end fingerprint machine.
- ◆ Duress to enter.
- ◆ Overtime for C2 connection with fingerprint machine.

Trouble proof:

- ◆ When the C2 communication controller has unlocked, if the communication between C2 and fingerprint machine occur failed, the lock still keep close.
- ◆ When the C2 communication controller give a warning, if fail to connect with fingerprint machine and C2 communication controller, the C2 communication will keep alarm state.
- ◆ If the C2 communication breaks down push its reset key, the C2 communication box will restart.
- ◆ If the front-end fingerprint machine trouble occur, push its reset key, the C2 communication controller and the fingerprint machine will restart together.
- ◆ If the front-end fingerprint machine breaks down, restore the machine through following routine, use an tool which diameter is no more than 2MM plug into reset hole of the fingerprint machine, this routine the time is not over 2 second, thus C2 will restart along with the front –end fingerprint machine.

Power input and output

- ◆ Power Supply AC 220V.
- ◆ Fingerprint Machine Power Supply 12V .
- ◆ Alarm Current output 12V. <0.5A.

) Video phone parameters

Color video phone specifications

Power requirements: DC16V

power: standby: <0.5 W; work: ≤ 10 W

Monitor: 5-inch color screen

video input: 1 V_{p-p}

Auto- shutdown: monitoring timing: 1 minute speaking time: 1 minute

Door bell : Double Music "Ding Dong" Sound

temperature: -15 °C - +50 °C

Size: 185 (L) × 130 (W) × 27 (H) mm

Black write video phone specifications:

Power requirements: DC15V

power: standby: <1 W; work: \leq 10 W

CRT: Ultra-A-4-inch black-and-white flat tube

video input: 1 Vp_p

Auto-shutdown time: monitoring timing: 1 minute speaking time: 1 minute

Door bell: disyllabic "Ding Dong" Sound

temperature: -15 °C - +50 °C

Size: 225 (L) × 170 (W) × 52 (H) mm

8. Troubleshooting

Case	check content	Deal with way
Power indicator is failure	Check power wire, whether it become loose or on power	Join wire well again or change the power switch.
After User to be authenticated, fail to unlock	Check user's privilege	Check Time Zone, Group Time Zone, reset the user privilege.
Fail to communicate with fingerprint machine.	Power off, check whether the communication cable connection is firm or not. Check the DIP switch setup in the C2 or fingerprint machine. Check whether clear Binding ID or not	Connect cable well again; reset the DIP in properly position. Note: the different fingerprint has different DIP number
The relay fail to act after user to be authenticate	Check connection cable and relay	Renew relay

Note: information in this document is subject to change without notice

Information in this document is subject to change without notice
Printed in China